

BALLUFF

Vision Solutions

SIMPLIFY INDUSTRIAL VISION APPLICATIONS



B innovating automation

Balluff Vision Solutions

INDUSTRIAL IMAGE PROCESSING WITHOUT LIMITS.

 *innovating automation*

Outstandingly well-positioned for modern production

Industrial image processing is indispensable for modern, flexible manufacturing. It ensures product quality and enables efficient manufacturing processes. Balluff BVS vision solutions open up a variety of powerful applications for visual quality control, identification and positioning. Whatever you need to do, the possibilities of our portfolio for industrial image processing are virtually unlimited: whether monitoring position, size, orientation and distance of objects, checking for completeness, traceability of data or quality checking each individual production stage.

With our Smart Vision solutions you uncover processing errors early, enable fast corrections and prevent scrap batches to reduce your costs. And best of all: our image processing products are simple to set up and intuitive to operate – with no prior knowledge.

You also stabilize your entire production process with our cameras because these can be configured so that only the information needed for the controller flows through the process network. All other data are sent to a separate Gigabit Ethernet network. This minimizes data load and secures your process network.

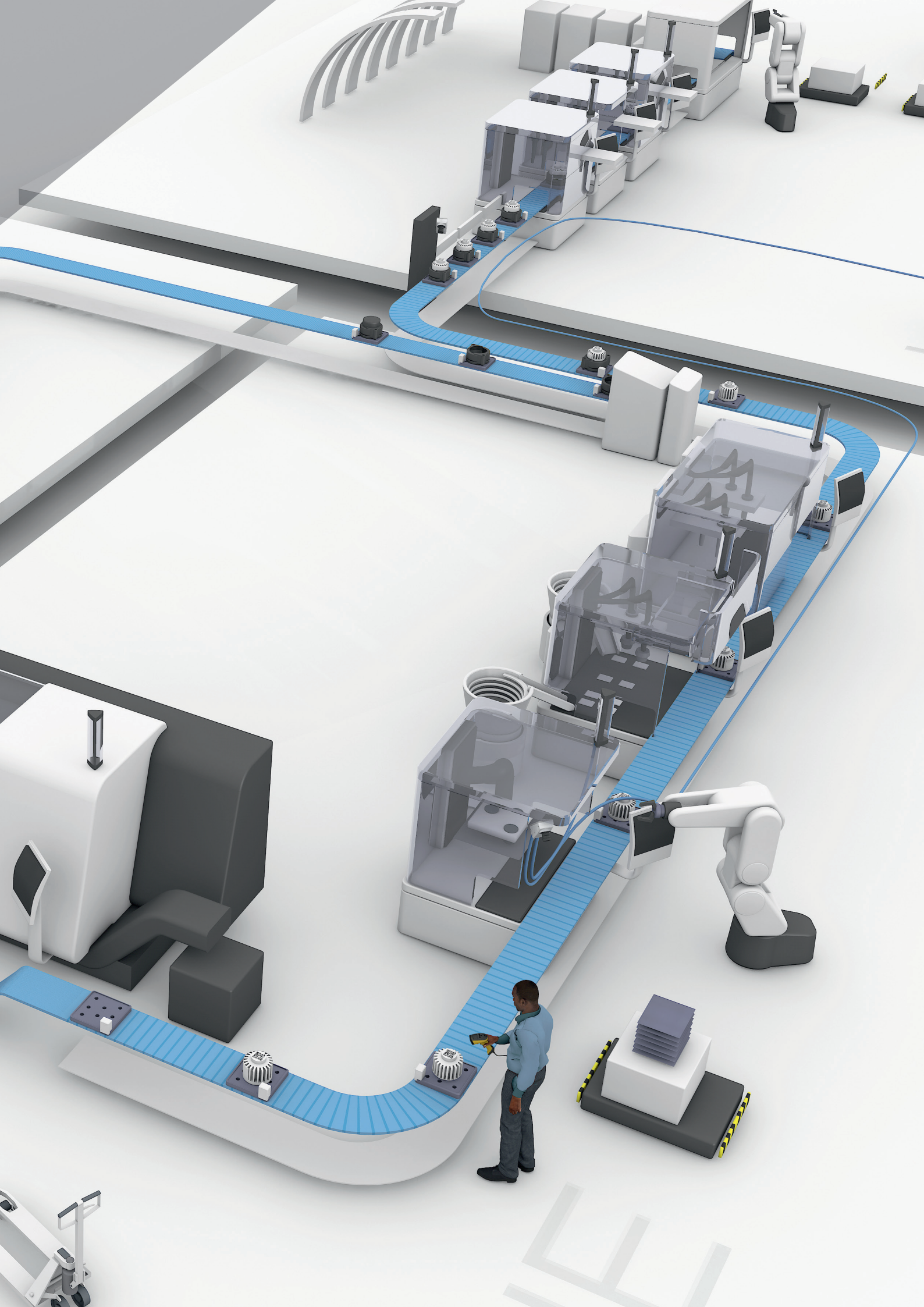

Versatile in use – easy to operate

SMART VISION SOLUTIONS

 *innovating automation*

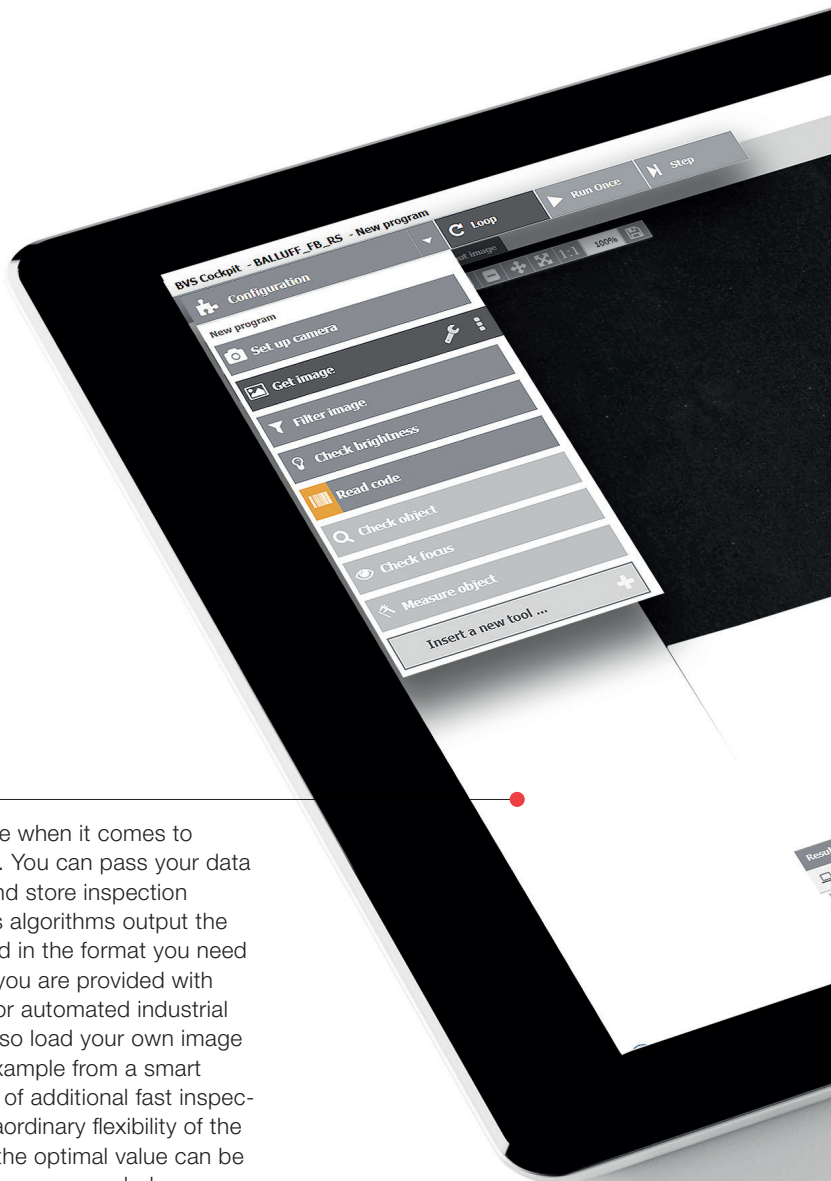

They are also highly flexible when it comes to selecting camera versions. You can pass your data directly to the controller and store inspection reports. Intelligent analysis algorithms output the results on the interface and in the format you need them. To accomplish this you are provided with various interfaces suited for automated industrial systems. Since you can also load your own image files to the cameras, for example from a smart phone, you can make use of additional fast inspection possibilities. The extraordinary flexibility of the image processing means the optimal value can be obtained from the data whenever needed.



For system support we have integrated online help and user interface manuals. The design of the system architecture means these – as well as the program, calibration templates and statistical evaluation – are always up-to-date.

Our Smart Vision solutions open up a variety of applications for image processing according to individual specifications. The SmartCamera and Industrial Camera are simple and intuitive to operate thanks to the well-designed BVS Cockpit software. The user interface shows you all the important functions. Both the monitor as well as the configuration and statistics modes are clearly represented. For all the tools you see only the parameters needed for the setting, so that you can conveniently adapt both our SmartCamera and our Industrial Camera to your needs. Selecting the hard- and software makes the functional scope easy to scale.

Intuitive

BVS-COCKPIT NO EXPERTISE REQUIRED

The BVS Cockpit user interface makes it easy to access all functions. You can intuitively set up our cameras with no prior knowledge. In short: our camera concept is designed for everyone.

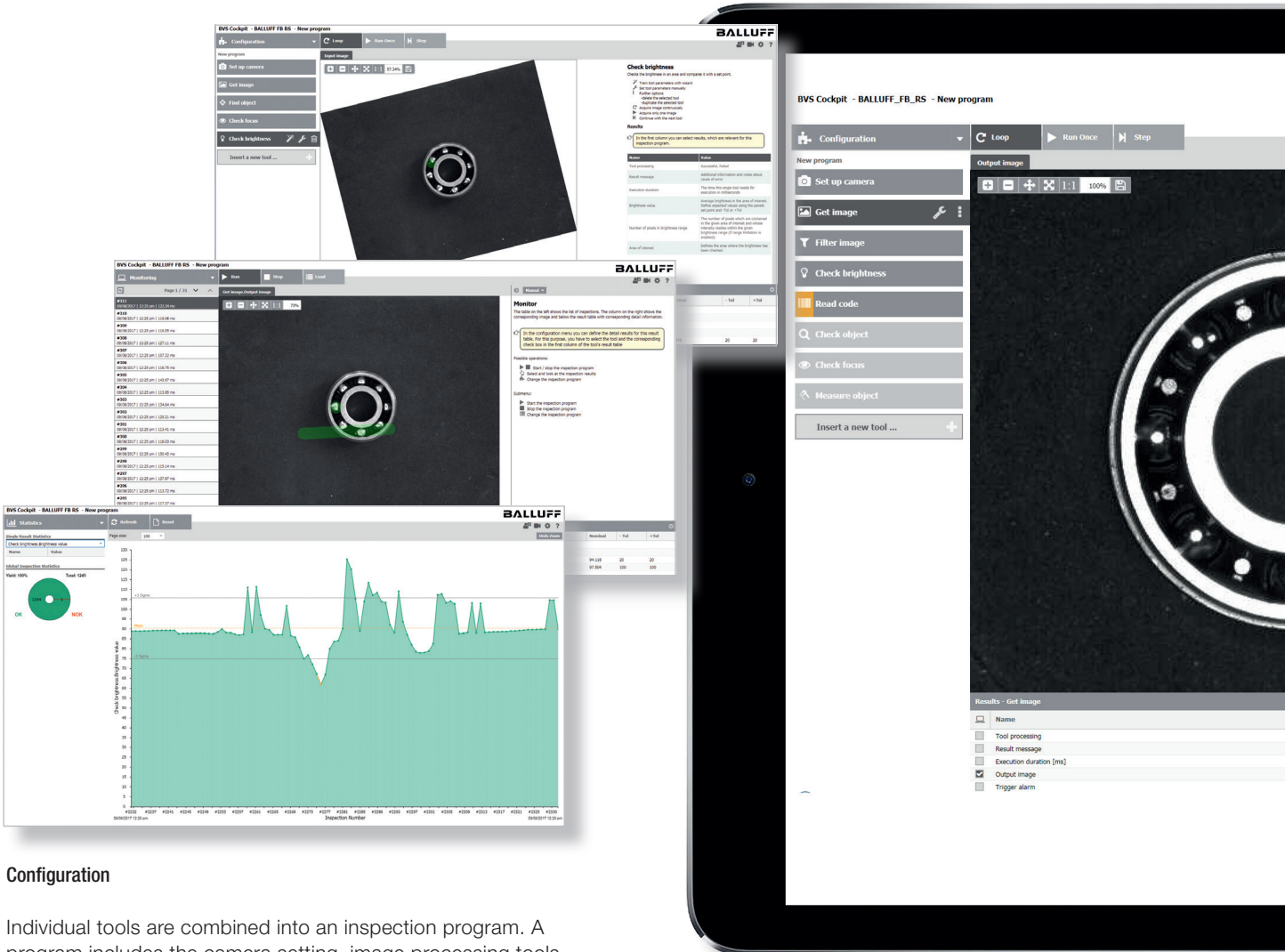

Configuration

Individual tools are combined into an inspection program. A program includes the camera setting, image processing tools and definition of the results data.

Monitor

The monitor shows you the current inspection program. The SmartCamera can store up to 100 inspection programs which you can select individually either directly or through the controller.

Statistics

While the camera is performing an inspection you can access the statistics, view the entire production quality and analyze the results parameters statistically and in timely fashion. Just a click lets you switch from a graph point to the associated inspection display in Monitor mode.

Image processing tools

Simple to use, flexible and reliable. The SmartCamera offers intuitive operation and simple to use tools which are based on industry-standard HALCON basic algorithms – all of which ensures you of fast and reliable solutions.

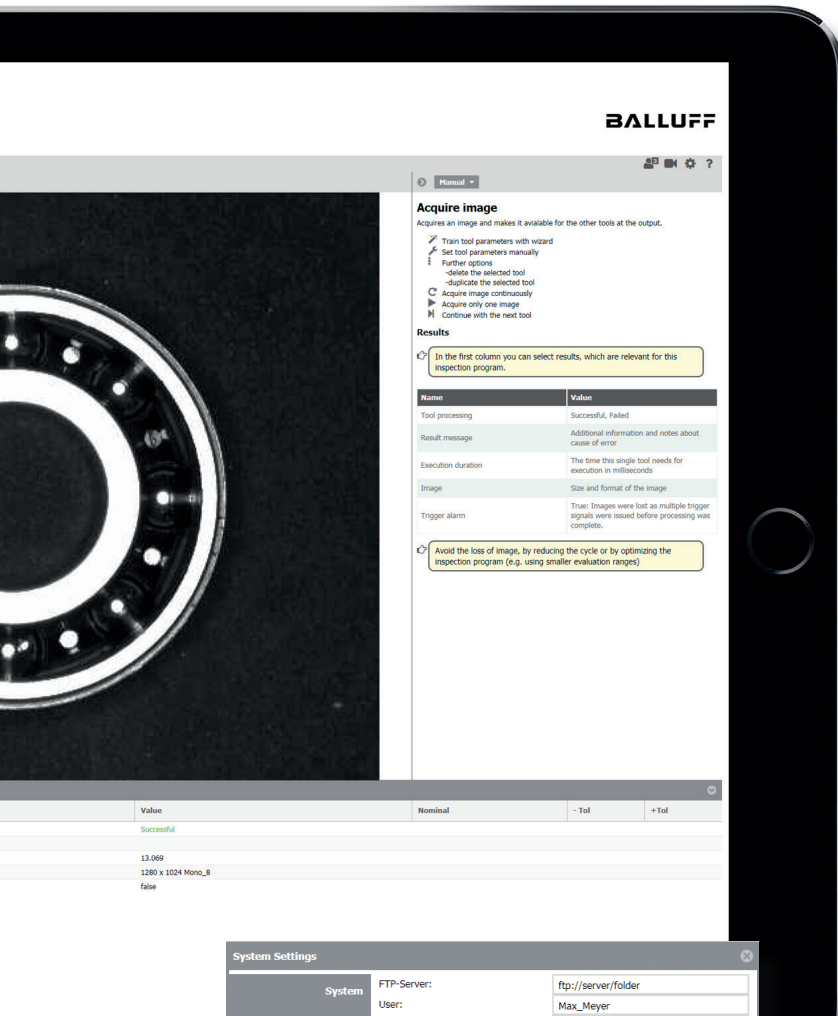
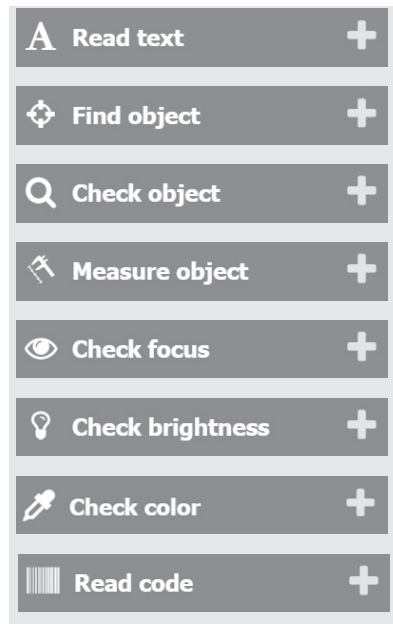

Interface tools

Results can be passed dynamically to the appropriate interface for the particular industrial system.

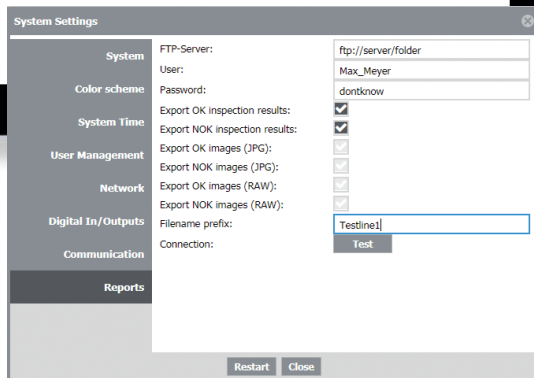
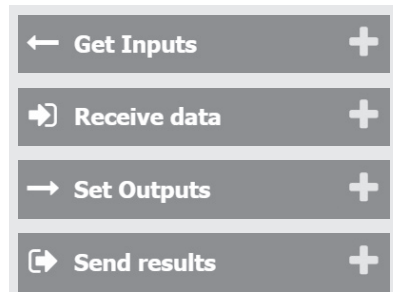

Store test reports

You can automatically create a results report in XML-format after each inspection and save the associated images to an FTP server. The storage condition can be defined with filter settings (ok/nok).

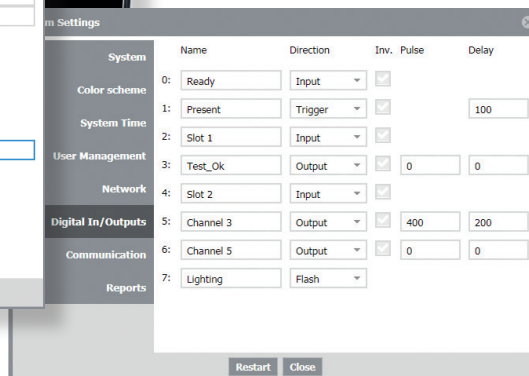

Definition of inputs and outputs

Up to eight digital channels are assigned to electrical connector pins by type, function and time behavior.

Easy to integrate, cost-saving and flexible

SMARTCAMERA



BVS SL
SMARTCAMERA LITE



	BVS003U	BVS003R	BVS003W	BVS003T	BVS003P
Description	SmartCamera Lite Tracking	SmartCamera Lite Tracking	SmartCamera Lite Ident	SmartCamera Lite Mono	SmartCamera Lite Color
Application area	Image acquisition and image storage	Image acquisition and image storage	Identification	Identification, general image analysis	Identification, general image analysis
Principle	CMOS, 1/1.8", monochrom, Global Shutter	CMOS, 1/1.8", color, Global Shutter	CMOS, 1/1.8", monochrom, Global Shutter	CMOS, 1/1.8", monochrom, Global Shutter	CMOS, 1/1.8", color, Global Shutter
Image resolution	1280 × 1024 Pixel	1280 × 1024 Pixel	1280 × 1024 Pixel	1280 × 1024 Pixel	1280 × 1024 Pixel
System interface	Gigabit Ethernet	Gigabit Ethernet	Gigabit Ethernet	Gigabit Ethernet	Gigabit Ethernet
Process interface	TCP, UDP, RS232	TCP, UDP, RS232	TCP, UDP, RS232	TCP, UDP, RS232	TCP, UDP, RS232
Digital interface	6 x I/O	6 x I/O	6 x I/O	6 x I/O	6 x I/O
Housing material	Painted aluminum	Painted aluminum	Painted aluminum	Painted aluminum	Painted aluminum
Size	65 x 40 x 99.5 mm	65 x 40 x 99.5 mm	65 x 40 x 99.5 mm	65 x 40 x 99.5 mm	65 x 40 x 99.5 mm
Type of protection IEC 60529	IP67 (with protective tube)	IP67 (with protective tube)	IP67 (with protective tube)	IP67 (with protective tube)	IP67 (with protective tube)



BVS SC
SMARTCAMERA



HALCON
a product of MVTec

	BVS002A	BVS0029	BVS002F	BVS0033
Description	SmartCamera Feldbus	SmartCamera Ident	SmartCamera Color	SmartCamera Hdevelop
Application area	Identification, general image analysis	Identification	Identification, general image analysis	Identification, general image analysis, Hdevelop script import
Principle	CMOS, 1/1.8", monochrom, Global Shutter	CMOS, 1/1.8", monochrom, Global Shutter	CMOS, 1/1.8", color, Global Shutter	CMOS, 1/1.8", monochrom, Global Shutter
Image resolution	1280 x 1024 Pixel	1280 x 1024 Pixel	1280 x 1024 Pixel	1280 x 1024 Pixel
System interface	Gigabit Ethernet	Gigabit Ethernet	Gigabit Ethernet	Gigabit Ethernet
Process interface	Profinet, Ethernet/IP, TCP, UDP, IO-Link	Profinet, Ethernet/IP, TCP, UDP, IO-Link	Profinet, Ethernet/IP, TCP, UDP, IO-Link	Profinet, Ethernet/IP, TCP, UDP, IO-Link
Digital interface	8 x I/O	8 x I/O	8 x I/O	8 x I/O
Housing material	Painted aluminum	Painted aluminum	Painted aluminum	Painted aluminum
Size	62 x 55 x 110 mm	62 x 55 x 110 mm	62 x 55 x 110 mm	62 x 55 x 110 mm
Type of protection IEC 60529	IP67 (with protective tube)	IP67 (with protective tube)	IP67 (with protective tube)	IP67 (with protective tube)

Smart

WITH APPLICATION-SPECIFIC INFORMATION

Versatile linking to the production environment

BVS SL SMARTCAMERA LITE

- TCP-/IP-LAN connection (Gigabit Ethernet) and up to eight freely programmable, potential-isolated in-/outputs
- Lights can be directly controlled



BVS SC SMARTCAMERA

- TCP-/IP-LAN connection (Gigabit Ethernet)
- Profinet or Ethernet/IP process interface
- For simple networking with IO-Link master 1.1 components
- Up to eight freely programmable in-/outputs
- Reduces load on the process network: optional separation of process data and reports with images
- Lights can be directly controlled



Configuration and process control are integrated

The SmartCamera includes the complete user interface software. The image processing tools are based on the HALCON function library.



The images are recorded at the highest quality, analyzed as appropriate for the application, and passed along to the controller. Use the serial number to access the SmartCamera from common Web browsers (Google Chrome, Mozilla Firefox, Internet Explorer, Edge). This enables simple remote access even from distant locations. Integrated process controls such as brightness, focus or status indication can be set as desired.

Flexible data preparation for the system environment

The SmartCamera has flexibility for linking to the system environment. Configure and assign individual signals as required. Results data can also be variously defined and formatted. The SmartCamera passes these data to the host control system. Likewise, the object data and serial numbers can be integrated into the inspection sequence.

To minimize data load and secure the process network, you can configure the camera so that only the information the controller needs runs through the process network. All other data are sent to a separate Gigabit Ethernet network. Alternately, a simple software click allows combined operation over a network connection.

Designed for industry

- Rugged IP67 enclosure
- Flexible mounting
- Standardized M12 connection for all interfaces

Versatile – for optimal results

SOLUTION OVERVIEW



IO-Link products (directly controlled)

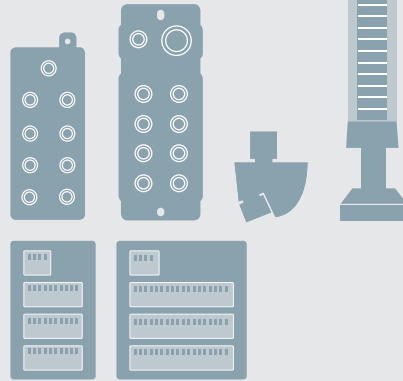

Fastening elements



Power supply

Gigabit Ethernet

Profinet

Ethernet/IP

Extensions

Y-couplers

In-outputs

IO-Link



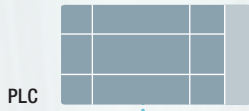

EtherNet/IP™

PROFINET®

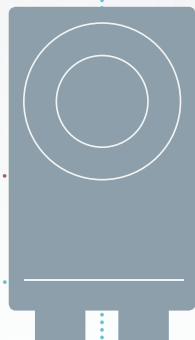

SmartCamera
monochrome,
color, IO, fieldbus

Display



12" Windows 10 IOT

Power supply units



Optics



C-mount lens
6...75 mm focal length



Filters
Polarizing, red, infrared



Protection tube
Aluminum 40 or 71 mm

Lights



Ring light
100 mm
red/white/
infrared



Line light
85 ...200 mm
red/white/
infrared



Machine light
170...300 mm
white



Dark Field
Light
90 mm red



Background
light
25 ...300 mm
red/infrared



Coaxial light
50/100 mm
red



Spot light
12 ...30 mm
red/infrared



Line laser

Fast, compact and high-performance

INDUSTRIAL CAMERA

High-performance industrial system with BVS Cockpit and industrial controller

With our Industrial Cameras you use outstanding images and profit from extremely fast image transfer. Select between color or black-and-white and four different image resolutions. This offers you great flexibility in installation because wherever you locate the camera, its high resolution guarantees you tack sharp images even over large image fields – and therefore the best inspection results. Also good to know: their compact form factor makes installation possible even in tight spaces.

For use with the BVS Cockpit system, our Industrial Cameras need an industrial controller into which the software is integrated. Since you can enable multiple cameras simultaneously on one controller, you are able to perform multiple inspections.

For example, one inspection can involve different angles of view at the same time. This not only increases the quality of the inspection, but is also especially cost-saving, since you can easily and simply initiate multiple queries and process their results simultaneously via the industrial controller.

The BVS Cockpit is also an integral part of this high-performance camera, so that like the SmartCamera it is highly user-friendly. You can conveniently perform setup to your individual requirements with no previous knowledge or expertise. And its various interfaces with GigE or USB3 mean the Industrial Camera can be integrated into any industrial network.

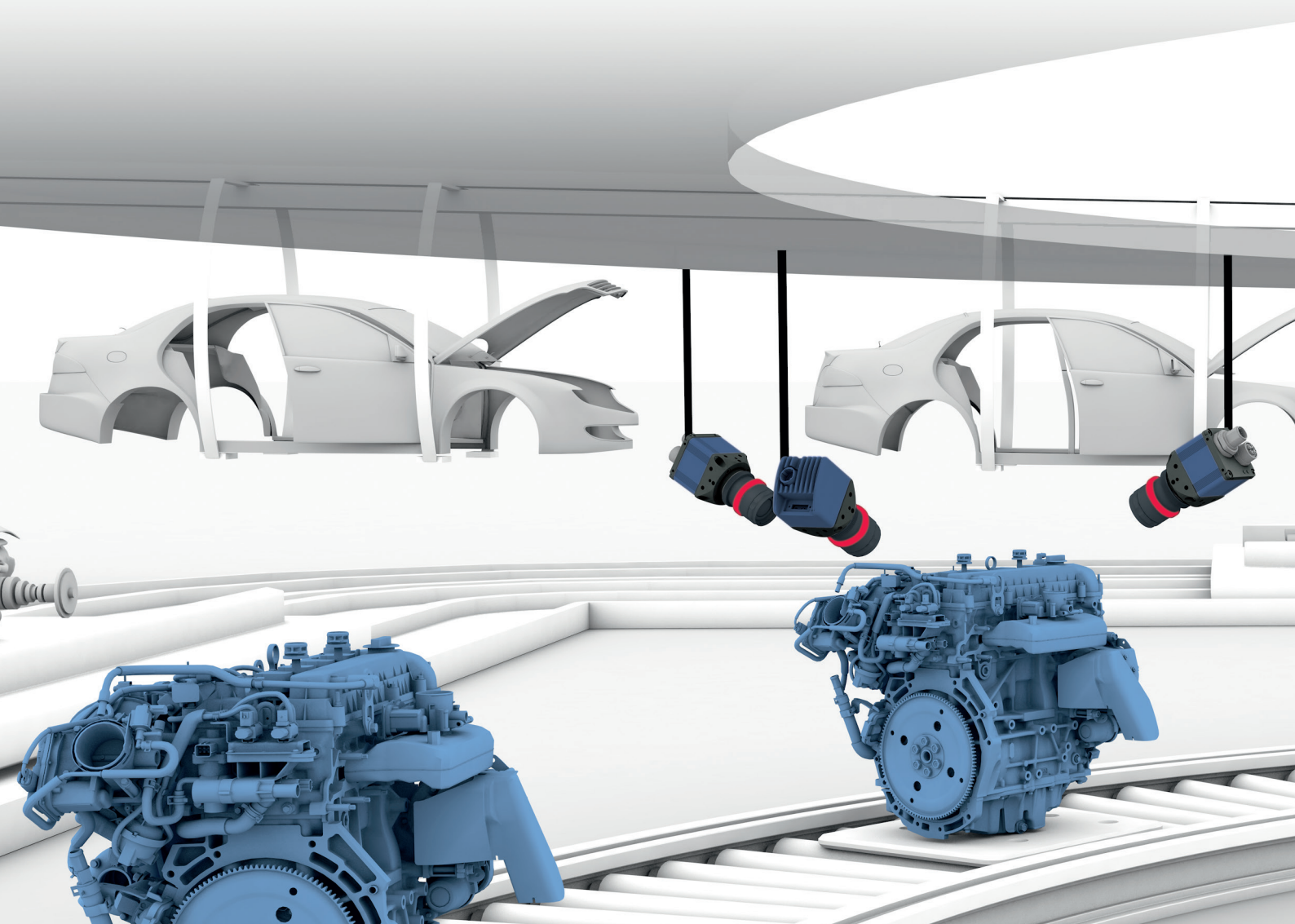

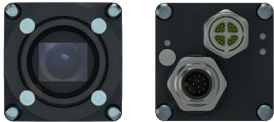

Optimized recording of inspection images

GIGE VARIANTS

- GigE-Vision interface plus four inputs and four outputs
- Standard-Gen<i>Cam programming interface

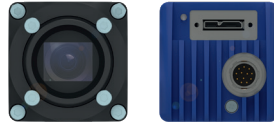

Optimized recording of inspection images

USB3 VARIANTS

- USB3-Vision interface plus two inputs and four outputs
- Standard-Gen<i>Cam programming interface



Process and analyze multiple camera image data and forward the results

SMARTVISION CONTROLLER

- Multiple USB3 or GigE camera connections
- Versatile LAN and process interfaces

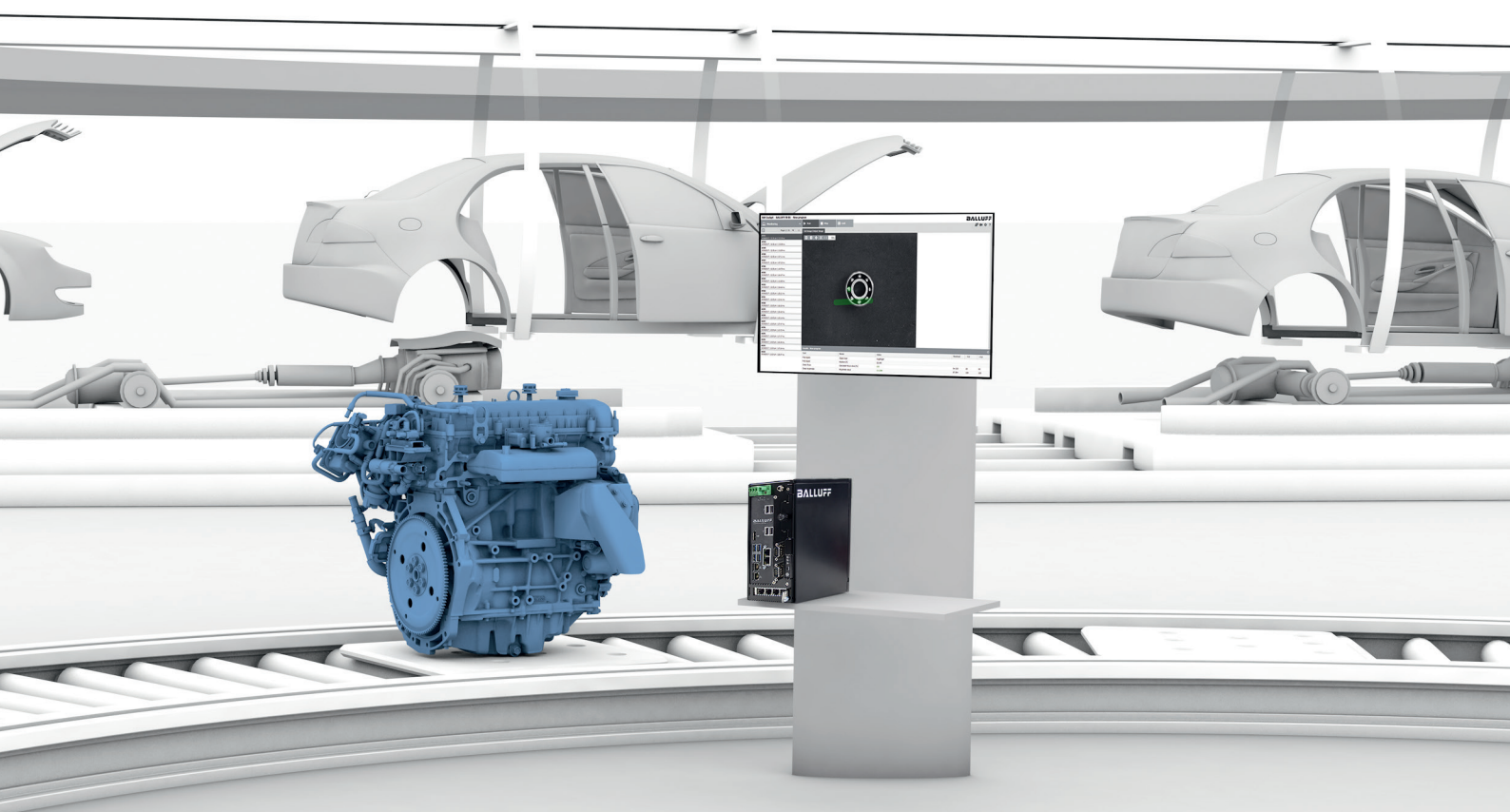

High-performance cameras for economical solutions

INDUSTRIAL CAMERAS

NEW



INDUSTRIAL CAMERA

Monochrome, 1.6 MP	BVS003A	BVS003M
Color, 1.6 MP	BVS003C	BVS003N
Monochrome, 3.2 MP	BVS0038	BVS003K
Color, 3.2 MP	BVS0039	BVS003L
Monochrome, 5.1 MP	BVS0036	BVS003H
Color, 5.1 MP	BVS0037	BVS003J
Monochrome, 12.4 MP	BVS0034	BVS003E
Color, 12.4 MP	BVS0035	BVS003F
Dimension	40 x 40 x 68.7 mm	40 x 40 x 50.9 mm
Sensor chip	CMOS	CMOS
Lens	C-Mount	C-Mount
Data interface	GigE Vision	USB3 Vision
Digital interface	4 inputs, 4 outputs	2 inputs, 4 outputs
Operating temperature	0...+45 °C	0...+45 °C
Housing material	Aluminum	Aluminum
Protection degree	IP67	IP30
Weight	140 g	110 g

Not included: Lenses, connection cable and other accessories – see www.balluff.com



SMARTVISION CONTROLLER

	BAE0103
Description	SmartVision Controller
Dimension	192 × 229 × 88 mm
Power supply	15...24 V
Operating system	Linux, BVS-Cockpit
Processor	i7 – 6700TE
RAM	16 GB DDR4
Hard drive	256 GB SSD
Interfaces	2 × LAN 4 × GigE-LAN 4 × USB3 4 × USB2 2 × Profinet
Application software	BVS-Cockpit with HALCON license
Operating temperature	+10...+50 °C
Housing material	Steel sheet metal, coated
Weight	2700 g

Power supply and mounting system included in scope of delivery

Versatile – for optimal results

SOLUTION OVERVIEW.

 *innovating automation*

Connections

GigE Vision

GigE IO

USB3 Vision

USB3 IO

PROFINET Controller

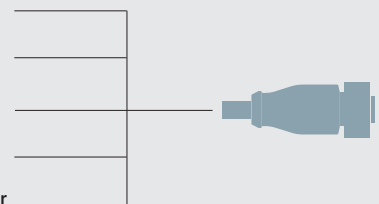

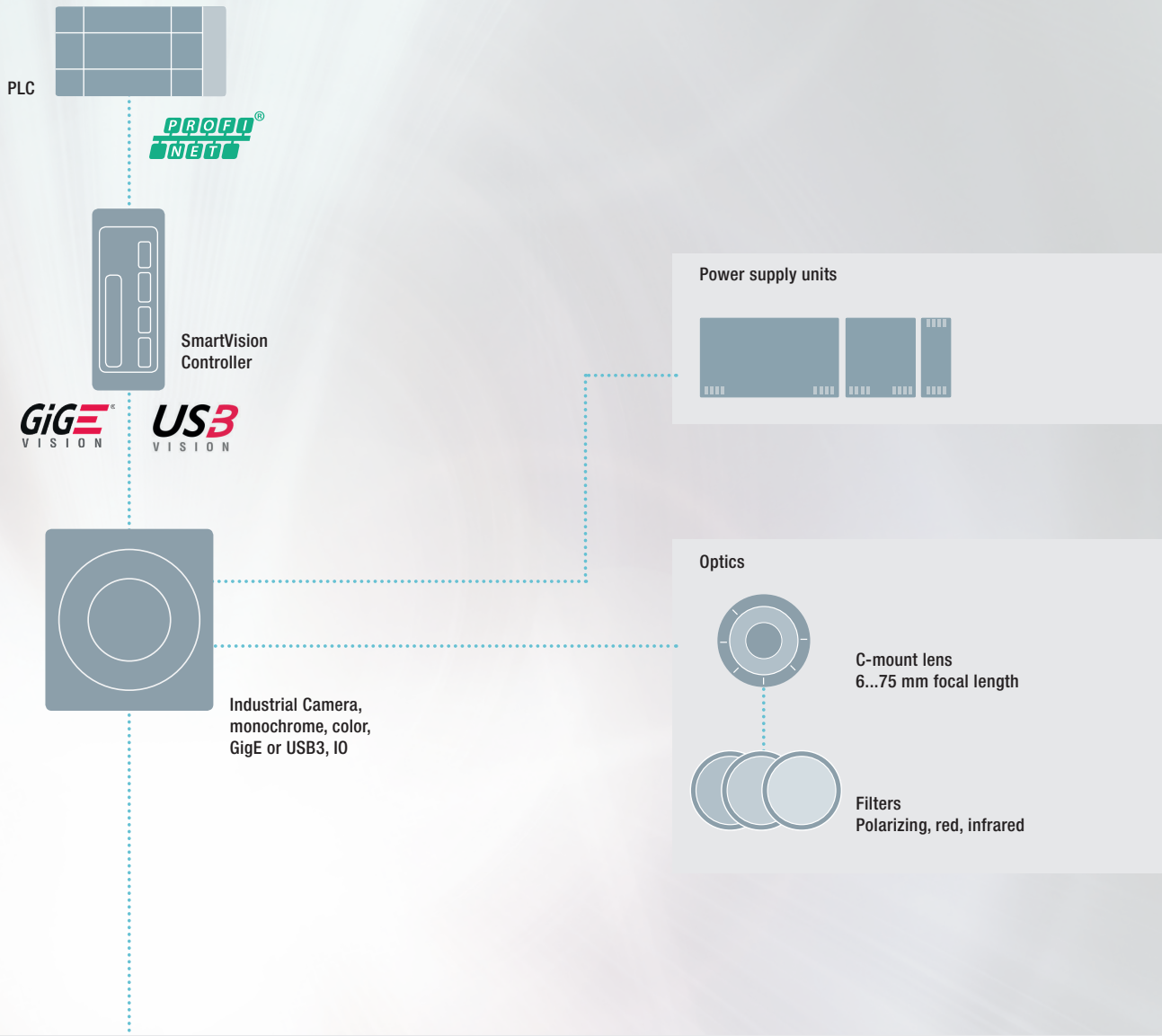



Lights

- 

Ring light
100 mm
red/white/
infrared
- 

Line light
85 ...200 mm
red/white/
infrared
- 

Machine light
170...300 mm
white
- 

**Dark Field
Light**
90 mm red
- 

**Background
light**
25 ...300 mm
red/infrared
- 

Coaxial light
50/100 mm
red
- 

Spot light
12 ...30 mm
red/infrared
- 

Line laser

Smart quality inspection

TRACEABILITY

Vision solutions for secure identification and decoding of objects

Our range of services for optical identification includes stationary barcode readers, mobile handheld readers and accessories for standard and industrial grade applications. All devices offer decoding options for the standard 1D or 2D barcodes. Their use lets you reliably trace products and assembly operations. For example in production control, controlling replenishment processes such as kanban systems, or for optical tool identification. And all the devices are simple to place in service.

You can choose industrial grade handhelds with outstanding read performance and mobile versions that offer maximum freedom of movement. The rugged readers combine maximum reading performance with user friendliness.

Also available are handhelds for reading all common 1D and 2D, stacked barcodes and post codes. These can be used in any orientation (up to 40° of tilt) and while moving. For example in-house logistics, storage space assignment in the area for small parts storage, commissioning or document management. They are intuitive to operate, and the ergonomic shape and low weight eliminate fatigue and are easy on the user's hands.

Our stationary code readers in the compact housing reliably read 1D or 2D as well as stacked codes at up to 40 times per second. It makes no difference whether the codes were adhered with a label, printed on, laser etched or directly marked. Even position deviations are not a problem.



RS232/USB	BVS001W	BVS001T			
Bluetooth 3.0/RS232	BVS0021	BVS001Z			
Bluetooth 3.0/USB 3	BVS0020				
Ethernet 10/100 Base T			BVS0001	BVS0019	
Gigabit Ethernet					BVS003W
Application area	Identification Barcode, 2D	Identification Barcode, 2D, DMC	Identification Barcode, 2D	Identification Barcode, 2D	Identification Barcode, 2D, OCR
Image resolution			640 × 480 pixels	640 × 480 pixels	1280 × 1024 pixels
Focal length			8 mm	8 mm	C-Mount
Illumination	LED, red light	LED white light	LED, red light	Infrared	
Process interface					TCP, UDP, RS232
Digital interface			1 × Trigger, 1 × Select, 3 × Output	1 × Trigger, 1 × Select, 3 × Output	6 × I/O
Size	163 × 41 × 91 mm	212 × 74 × 110 mm	51.5 × 70 × 40 mm	51.5 × 70 × 40 mm	62 × 55 × 110 mm
Weight	200 g	330 g	122 g	122 g	360 g
Type of protection IEC 60529	IP42	IP65	IP54	IP54	IP67 (with protective tube)
Operating temperature	0...+50 °C	-20...+50 °C	-10...+55 °C	-10...+55 °C	0...+55 °C

Simple production testing

OBJECT DETECTION

Reliable defect detection through exact quality inspection

Vision sensors from Balluff meet the rising demands for maximum quality and great flexibility in modern production facilities. They detect, inspect and verify plain text. They provide reliable defect detection and thereby ensure an exact quality control. You can flexibly combine all the functions, so that you master a variety of inspection operations with just one sensor.

We offer various models for your individual requirements: a Standard version with seven independent inspection tools and up to twenty storable inspections, so that your production keeps running seamlessly even when changing tools. This is because for each changing batch the inspection task can be simply changed.

The Advanced version also guarantees high system availability in demanding and fast-running applications. This model offers all the features of the Standard version plus 360° location detection as well as logical operations for different features.

The Universal vision sensor is the all-rounder with a broad range of application possibilities. It also stands out with high-speed responsiveness. Up to 40 barcodes and DataMatrix codes per second can be read and verified. And with its especially powerful, contour-based image processing tools you can locate, inspect and count all the parts in any rotational orientation.



LED red light, focal length 6mm	BVS000E	BVS000L	BVS001L
Infrared, focal length 6mm	BVS0013	BVS0016	BVS001F
LED red light, focal length 8mm	BVS0003	BVS000J	BVS001M
Infrared, focal length 8mm	BVS0014	BVS0015	BVS001H
LED red light, focal length 12 mm	BVS0005	BVS000K	BVS001N
Infrared, focal length 12mm	BVS0012	BVS0017	BVS001J
LED red light, focal length 16 mm		BVS000W	BVS001P
Infrared, focal length 16mm		BVS0018	BVS001K
Description	BVS E Standard	BVS E Advanced	BVS E Universal
Application area	Standard tools (brightness, contrast, edge, pattern)	Standard tools, 360° pattern check, results linking	Standard tools, identification, 360° pattern check, contour tool, OCV, results linking
Image resolution	640 × 480 pixels	640 × 480 pixels	640 × 480 pixels
Working distance	50...1000 mm	50...1000 mm	50...1000 mm
System interface	Ethernet 10/100 Base T	Ethernet 10/100 Base T	Ethernet 10/100 Base T
Digital interface	1 × Trigger, 1 × Select, 3 × Output	1 × Trigger, 1 × Select, 3 × Output	1 × Trigger, 1 × Select, 3 × Output
Size	51.5 × 70 × 40 mm	51.5 × 70 × 40 mm	51.5 × 70 × 40 mm
Weight	122 g	122 g	122 g
Type of protection IEC 60529	IP54	IP54	IP54
Operating temperature	-10...+55 °C	-10...+55 °C	-10...+55 °C

Headquarters
Balluff GmbH
Schurwaldstrasse 9
73765 Neuhausen a. d. F.
Germany
Phone +49 7158 173-0
Fax +49 7158 5010
balluff@balluff.de



CONTACT OUR
WORLDWIDE
SUBSIDIARIES